



Apricus
AUSTRALIA

INSTALLATION
MANUAL
ALL-IN-ONE AIR SOURCE
WATER HEAT PUMP
WITH A 260L TANK

INSTALLATION
OPERATION
MAINTENANCE
WARRANTY

APHP-R290-260

Apricus®
HEAT PUMP

Quick Installation & Commissioning Guide

A Select installation location

- This unit is designed for outdoor installation only.
- Avoid installation in areas where falling debris, such as leaves, is prevalent.
- Avoid placing the system in locations with multiple walls or structures.

B Prepare the Base

- The unit should be installed on a concrete plinth or stable structure capable of sustaining weights in excess of 450kg.
- A minimum dimension of 600mm x 600mm is required. Please ensure that all four feet are supported by the base being used otherwise warranties may be voided.
- The system is to be installed level.

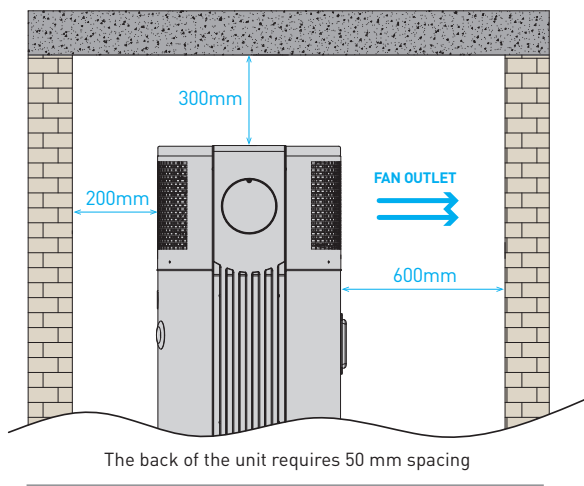

CONCRETE BASE

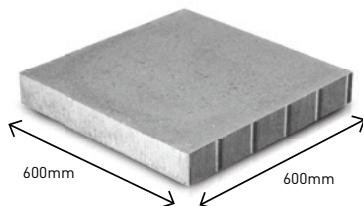

C Plumbing and wiring

This product MUST be wired on a dedicated circuit protected by a 20A circuit breaker. The system supplied with a 3-pin plug but 20A isolator switch hard wired to the system is highly recommended when electrician is available on site.

D Air bleed

Ensure at least one hot water tap is open inside the property. While the system begins filling with water, you will hear air being expelled from the open hot water tap. This ensures that no air pockets remain. Once water begins running out of the hot water tap, the system is completely bled and you can then turn the tap off. Please bleed air out of PTRV as well.

E Turning the system on

- Remove the controller cover by simply loosening hand screws.
- Unlock the screen by pressing the POWER button once.
- Press and hold the POWER button for 3 seconds until the SUN symbol flashes.
- Change the operational mode if required. The system has 4 operational modes, and the default mode is "ECO".
- Connect the controller to wifi and mobile app on the end user app.
- Return screen cover back onto unit after setting clock.

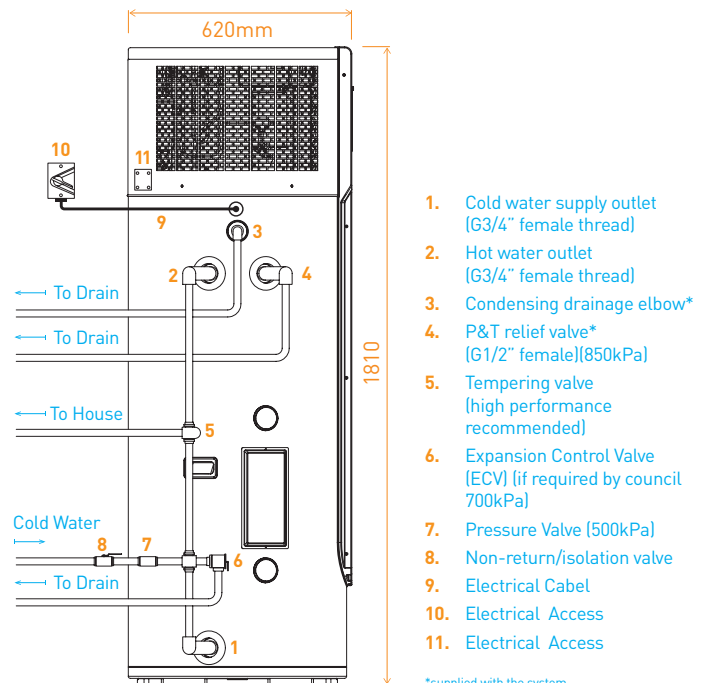

Tabel of contents

1	Warnings & Certifications	2
2	Terminology	4
3	Product Specifications Overview	5
3.1	Key parts in the all-in-one heat pump	5
3.2	Air Source Heat Pump	6
3.3	Storage tank	7
3.4	Smart Built-in Controller (Wi-Fi enabled) with power usage monitoring feature	8
4	How system works	9
5	Installation	11
5.1	Delivery	11
5.2	Location, Spacing around the unit, and Air flow	12
5.3	Base	13
5.4	Plumbing	14
5.5	Electric Wiring	18
5.5.1	Power Supply circuit	19
5.5.2	Wiring diagram	20
6	Controller and operational modes	21
6.1	Operational modes and timer settings	21
6.2	Illustrations on how to use the controller	23
6.3	Set Water Tank Temperature	24
6.4	Menu interface	24
6.4.1	Timer/timing	24
6.4.2	Wi-fi	25
6.4.3	Clock settings	26
6.4.4	Brightness settings	26
6.5	Query interface	26
6.6	Wi-fi and Mobile app set up	28
6.7	Mobile App (Smart Life)	30
7	Commissioning	32
7.1	Plumbing and electrical	32
7.2	Controller and operational mode set up	32
8	Error codes and troubleshooting	33
9	Maintenance	34
10	Warranty	34
10.1	Warranty periods	34
10.2	Heat pump warranty conditions	37
10.3	Warranty Registration – Lodge a claim	39

Warnings & Certifications

Certifications

This product has been tested against the following standards: AS 5125, AS 4692, AS 60335, AS 4020, AS 3498. The product is approved by SAA Approval, and it holds Watermark.



IMPORTANT

THIS APPLIANCE IS NOT INTENDED FOR USE BY PERSONS (INCLUDING CHILDREN) WITH REDUCED PHYSICAL, SENSORY, OR CAPABILITIES, OR LACK OF EXPERIENCE AND KNOWLEDGE.

Warning

1. This appliance may deliver water at high temperature. Refer to the Plumbing Code of Australia (PCA), local requirements and installation instructions to determine if additional delivery temperature control is required.
2. For Outdoor Use Only.
3. This appliance must be installed, commissioned, and serviced by an authorized person in accordance with all applicable national/local rules and regulations which include:
 - a. AS/NZS 3500.4 – National Plumbing and Drainage Code
 - b. AS/NZS 3000 – Electrical installation
 - c. AS/NZS 2712.2007 – Solar and Heat Pump Water Heaters: Design and Construction
 - d. AS/NZS AS 3498—2009 – Water heaters and hot-water storage tanks
 - e. The power cord chosen must be compliant with AS/NZS 3191 and the nominal cross-sectional area should be 1.5 mm² or more and should handle at least 20A (2 core and earth).
4. Removing the access cover or other water heating system components may expose 240V wiring therefore these components MUST only be removed by an authorized person.
5. If the systems power supply cord is damaged, it MUST BE replaced, this should be completed by an authorized person to ensure potential hazards are avoided.
6. Care should be taken not to touch the pipe work as it may be HOT and can result in injury!
7. DO NOT place articles on or against this appliance.
8. DO NOT activate (turn on) the heat pump unless the cylinder is full of water.
9. This product must be on its own dedicated 20 A power circuit and protected with a residual current device of 20 A rating [i.e., 20 A circuit breaker on the switchboard].

10. Please ensure that the instruction plate and/or warning plates on the unit must not be tampered with. These are attached to the external cover of the heat pump.
11. This product must only be installed and serviced by a qualified professional in the plumbing, Mechanical, and/or electrical industry.
12. A one-way isolating valve must be installed on the cold-water supply pipe to support maintenance activities.
13. If the power supply cord is damaged, it must be replaced by the manufacturer, its service agent, or similarly qualified personnel to avoid hazards.
14. To avoid a hazard due to inadvertent resetting of the thermal cut-out, the appliance must not be supplied with an external switching device, such as a timer, or connected to a circuit that is regularly switched on and off by the utility.

Installation & Operation

- Important notice: Please read this manual carefully before you attempt to install this product. Failure to do so may result in the product not working according to its design and may void the products warranty.
- This appliance uses R290 (propane) refrigerant, which is classified as a flammable gas (class 3) according to AS 1677 and must be serviced by a refrigeration mechanic with an appropriate Australian refrigerant handling license.
- If the refrigerant leaks, near an external ignition source, there is a possibility of ignition.
- DO NOT store chemicals or flammable materials near this appliance.
- NEVER use a flammable spray such as hair spray, paint, etc. near this unit as this may inadvertently result in a fire.
- Compliance with AS/NZS 5601 must be observed while storing the appliance.
- Do not pierce or burn the appliance.

- The appliance should not be stored or transported in an area with an ignition source (e.g. Open flame).
- National and state regulations exist for the storage, transportation and handling of hazardous goods including flammable gasses. The maximum number of and configuration of the equipment permitted to be transported or stored together will be determined by the appliance regulations.
- If a refrigerant leak is detected, switch off the unit at the mains and contact the service agent.
- DO NOT store chemicals or flammable materials near this appliance.
- If you suspect the refrigerant is leaking, then:
 - Do not smoke.
 - Do not operate electrical equipment. Isolate the device.
- End of life recycling
 - The refrigerant must not enter the atmosphere. The refrigerant can only be removed by qualified professionals.

WARNING – IF THE HOT WATER SYSTEM IS NOT USED FOR TWO WEEKS OR MORE, A QUANTITY OF HIGHLY FLAMMABLE HYDROGEN GAS MAY ACCUMULATE IN THE WATER HEATER. TO DISSIPATE THIS GAS SAFELY, IT IS RECOMMENDED THAT A HOT TAP BE TURNED ON FOR SEVERAL MINUTES UNTIL THE DISCHARGE OF GAS CEASES. PLEASE USE A SINK, BASIN, OR BATH OUTLET, FOR THIS PROCEDURE. NOTE A DISHWASHER, CLOTHES WASHER, OR OTHER APPLIANCE IS NOT SUITABLE. DURING THIS PROCEDURE, THERE MUST BE NO SMOKING, OPEN FLAME, OR ANY ELECTRICAL APPLIANCE OPERATING WITHIN TWO METRES OF THE HEAT PUMP OR THE TAP THAT IS DISCHARGING THE WATER. IF HYDROGEN IS DISCHARGED THROUGH THE TAP, IT WILL PROBABLY MAKE AN UNUSUAL SOUND AS IT ESCAPES, THIS IS NORMAL.

WARNING – FOR CONTINUED SAFETY OF THIS APPLIANCE IT MUST BE INSTALLED, OPERATED AND MAINTAINED IN ACCORDANCE WITH THE MANUFACTURER'S INSTRUCTIONS.

Terminology

The following table provides descriptive definitions of common terminology used throughout this manual and other documents and materials relating to your Air-Source CO2 Hot Water System.

ASHP	An Air-Source Heat Pump, which is a device including different parts such as evaporator and compressor that heats up water using ambient air as the primary energy source.
ACL	Australian Consumer Law – the national law for fair trading and consumer protection.
Claim	Any claim, action, proceeding, loss, damage, cost, expense or liability whatsoever incurred or suffered by or brought or made or recovered against any person.
Controller	A device used in the Heat Pump system to control the systems operational time and other set points which are required for the operation of the heat pump.
Corrosion	The process that involves deteriorating material due to oxidation.
Cylinder	Refers to the tank cylinder.
ECV	Expansion control valve: This is installed on the cold mains line to relieve excess pressure.
Electrical Conductivity	Amount of dissolved material in water, which relates to its ability to conduct electrical current through it.
Hardness	Water that is high in dissolved minerals.
Insulation	Materials used for heat retention.
pH Level	Measure of how acidic/basic water is.
PTR Valve	Pressure Temperature Relief Valve (PTRV): Installed on the hot water storage tank to relieve pressure, and excessive temperatures. The temperature default setting is 99°C for temperature and 850 kPa for pressure.
PLV Valve	Pressure limiting valve is installed on the cold main inlet of water to the system. The setting shall be 500 kPa.
Tempering Valve	A valve that mixes hot and cold water before supply to the hot water taps. The default setting is 50°C.
Storage Tank	Container holding volume of water.

Product Specifications Overview

3.1 Key parts in the all-in-one heat pump

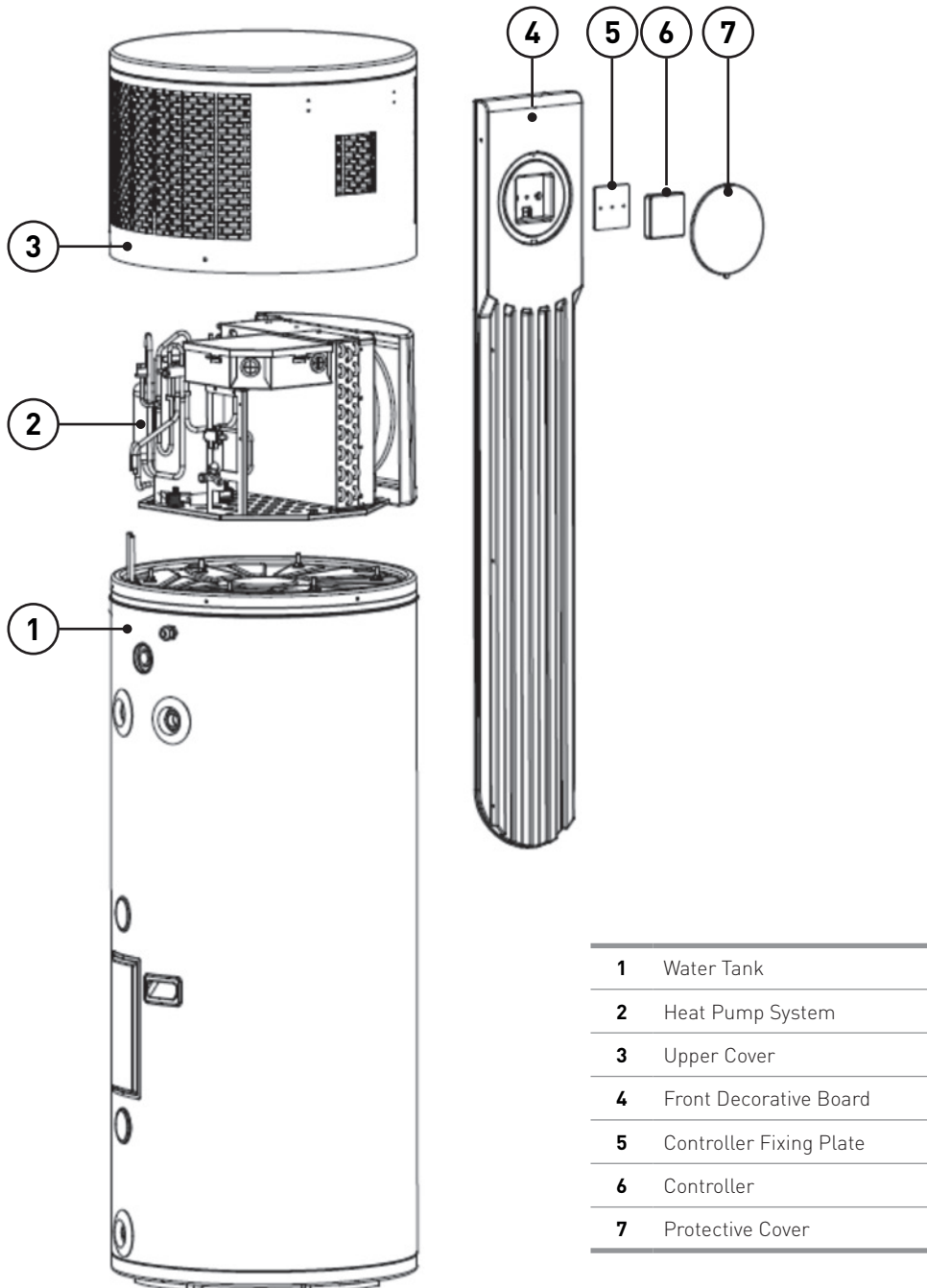

Figure 1 All-in-one heat pump key parts

3.2 Air Source Heat Pump

PARAMETER	UNIT	VALUE
Model Number	-	APHP-R290-260
Refrigerant	-	R290
Refrigerant Volume	g	400
Rated Voltage/Frequency	V/Hz	220-240/50
Hot Water Production Rate	L/hr	65
Maximum Input Power (Heat Pump & Element)	W A	2900 12
Rated Power & Current	Watts/Amp	665/ 3
Rated Heating Capacity & COP	W -	2750 4.49
COP at 22°C ambient & 20°C Water tank per AS 5125	-	6.74
Electric Element Rated Power & Current	Watts Amp	1800 8
Storage Tank Capacity	L	260
Water Pipe Size	Inch	G3/4
Waterproof Level	-	IPX4
Tank PTRV Rating	KPA	850
Noise	DB	43
Net Weight	KG	118
Installation Location	-	OUTDOOR
Operational Ambient Range	C	-7 to +43C
Compressor	-	GMCC/Toshiba - R290
Evaporator	-	Copper tube and aluminum fin type
Fan	-	Axial type
Tank	-	Enamel Carbon Steel
Heat Exchanger	-	Micro-channel wrap around water
Controller	-	Built-in touch screen with Wi-Fi

PRODUCT SPECIFICATIONS OVERVIEW CONT.

3.3 Storage tank

- The cylinder and heat pump are integrated.
- The heat pump is located on top of the storage tank.
- The tank is made of Carbon Steel, and it comes with a sacrificial anode as well as the electric anode. The electric anode will reduce the frequency of magnesium rod (anode) replacement.

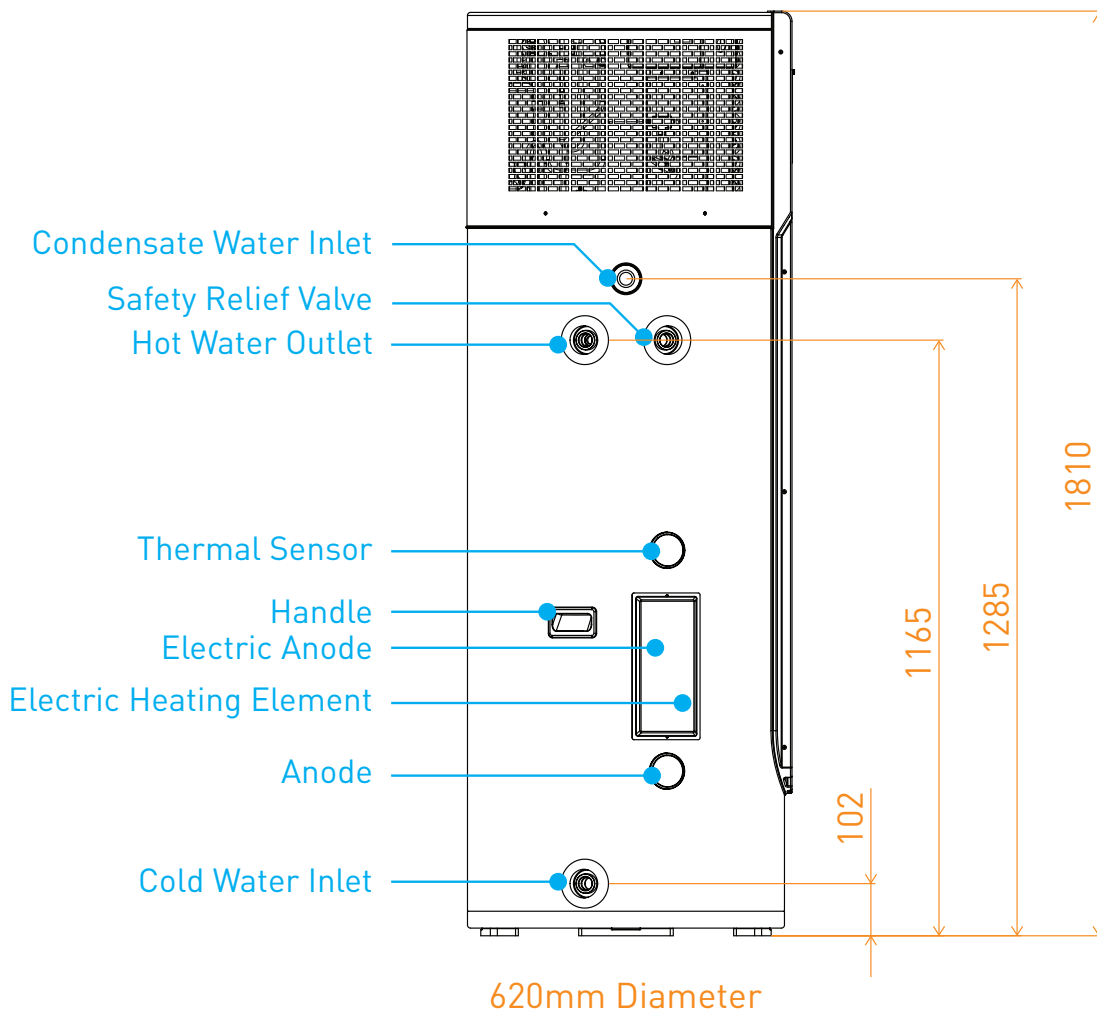

Figure 2 All-in-one heat pump and tank dimensions and port/sensor locations

3.4 Smart Built-in Controller (Wi-Fi enabled) with power usage monitoring feature

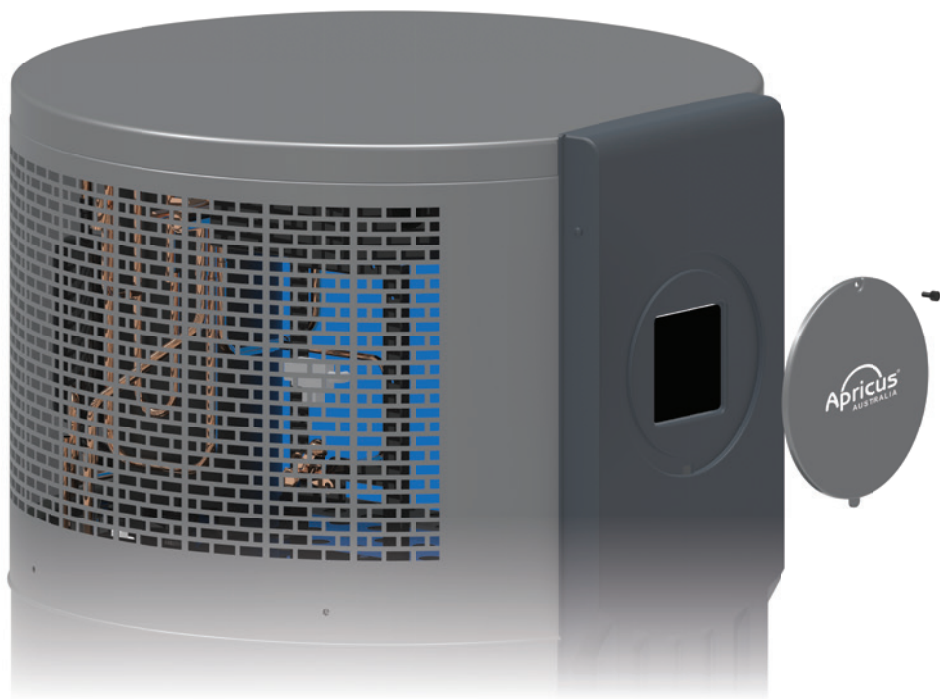

Figure 3 The Built-on controller is accessible by removing the front labelling cover



THE CONTROLLER IS NOT IP RATED SO THE COVER MUST BE ALWAYS IN PLACE AND FITTED IN THE WITH THE SCREW SUPPLIED.

The controller can be used for the following purposes:

1. To monitor the systems operational parameters such as tank temperature, power usage, ambient data, etc.
2. To change or adjusting the operation mode. The system has 4 operational modes. The default mode is "ECO" which relies on the heat pump for the supply of hot water exclusively (precludes input energy from the electric element).

How the System Works

The air source water heater heat pump has two main parts (see figures below).

Top Section

The top part of the heat pump encapsulates the following components: the compressor, evaporator, and fan. The air in the ambient is drawn into the unit via the axial fan and the energy from the air is absorbed by the R290 refrigerant through the evaporator (i.e., air to refrigerant heat exchanger). As the air is cooled down it exits from the side of heat pump. The refrigerant absorbs the thermal energy where it is superheated (extremely HOT). The superheated steam is transferred to the bottom section of the heat pump via refrigerant lines. These lines wrap around heat exchanger and the cooler refrigerant goes back to the top section of the heat pump and the heating cycle repeats.

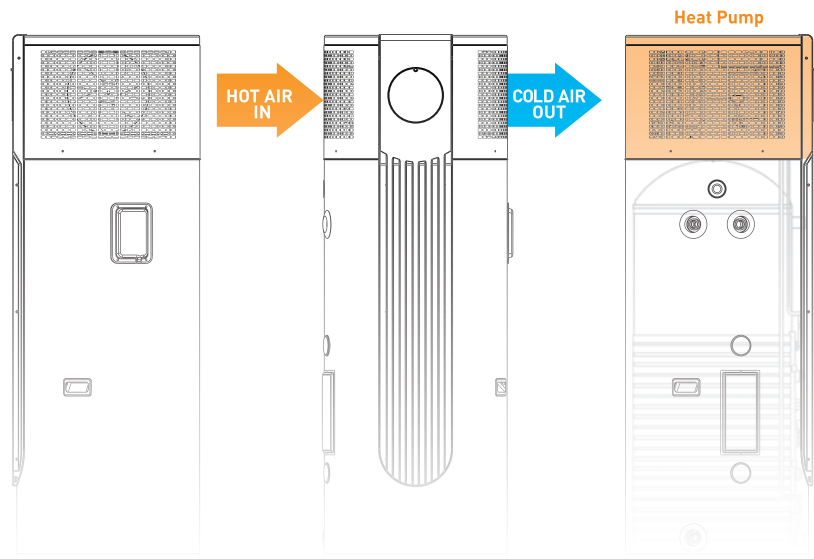

Bottom Section

The bottom section of the heat pump is where the heat transfer occurs via the coils which wrap around the storage tank. It must be noted that there is no direct contact between the water and refrigerant. The refrigerant receives heat from air and simply transfers that to the water tank via heat conduction using a microchannel wrap around heat exchanger.

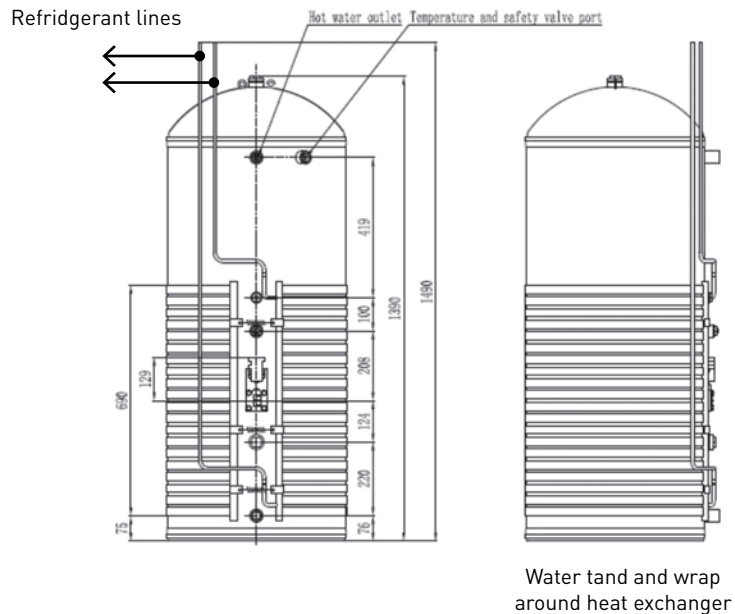

Figure 4 General schematic of how system works (internal and external of the heat pump system)

HOW THE SYSTEM WORKS CONT.

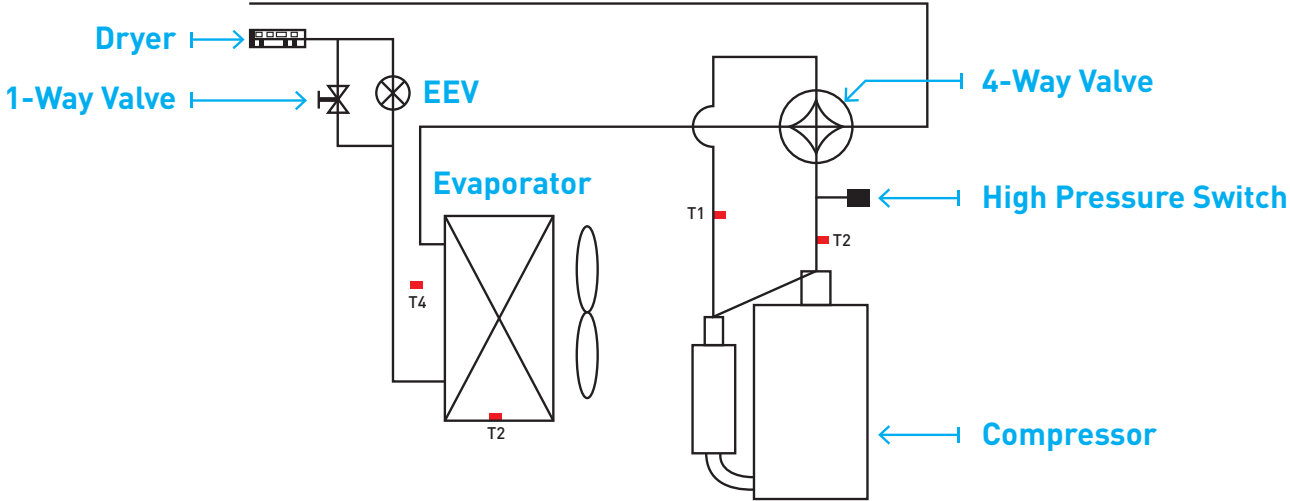
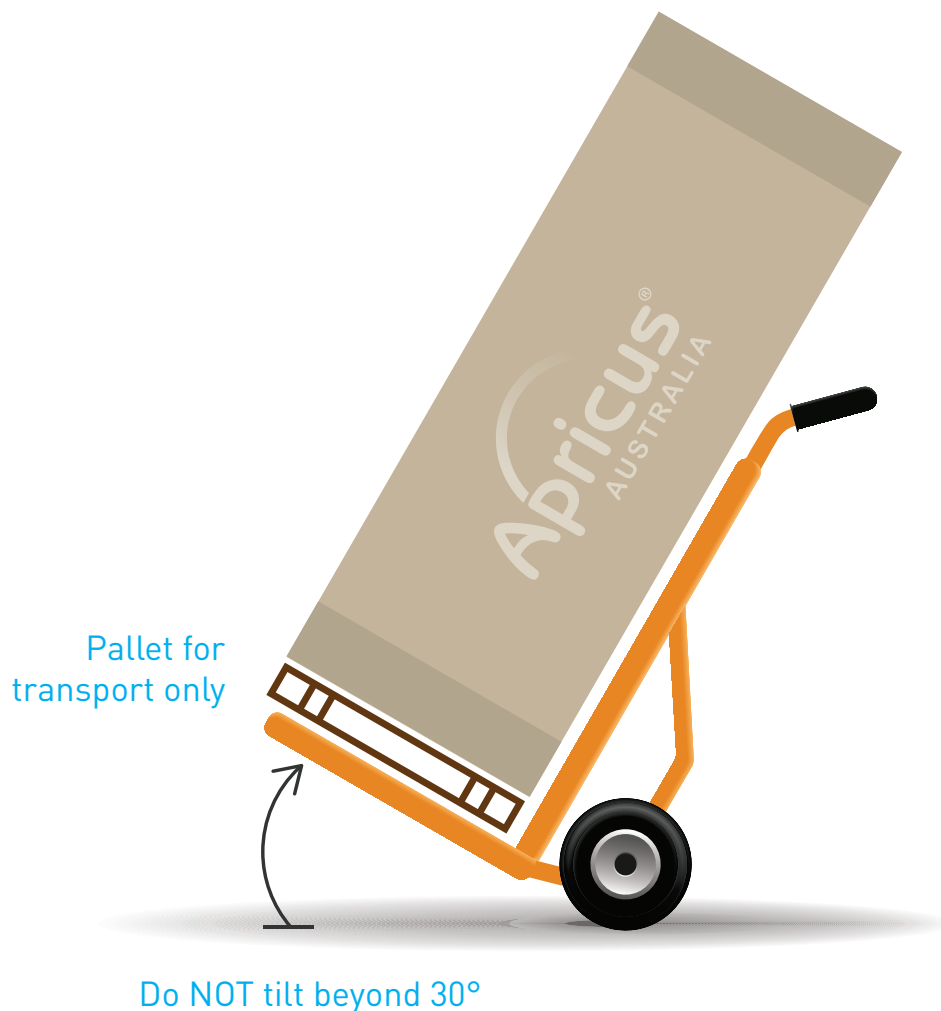

Figure 5 Heat Pump Components and refrigerant cycle

Installation

5.1 Delivery

- The heat pump must be always stored and transported in a near vertical position with a tilt ratio of no more than 30°. Transporting or storing the unit in a horizontal position will void the warranty.
- The system should always be transported in its packaging.
- Any marks caused by inappropriate handling are not deemed as defects and are not covered under warranty.



5.2 Location, Spacing around the unit, and Air flow

Location

- Do not install this equipment indoors.
- The location selected for the unit must allow sufficient space for installation and maintenance.
- The inlet and outlet fan must have no obstacles blocking them.
- Please ensure that the installation location complies with the requirements of AS/NZS 5601 as it pertains to the heat pumps that containing a flammable refrigerant.
- The electrical access point and display panel should always be accessible.
- It is recommended that the unit is not installed with two meters of any bedrooms.
- The installation location must be as close as possible to the internal hot water outlets.
- When installing the unit do not install it within a range of 3 meters from a neighbor's window or door (this excludes garage doors and/or sheds).

Air flow

- This unit is designed for external operation only and requires a continuous supply of air to operate efficiently.
- Avoid installation in areas where falling debris such as leaves is excessive
- Avoid placing the system in locations with multiple walls or structures (i.e., consult with Figure 7 and Figure 8).
- Always maintain the optimum perimeter from all structures (see below)
- If installed under fixtures or home eaves, there must be a minimum 300 mm clearance from the top of the unit, 600 mm on the right-hand side of the system (when facing unit) and on the left-hand side of the system. The unit must be installed a minimum of 50 mm off your home's wall so that the entire unit can be accessed during any servicing work as well as to prevent circulation of cold air.
- The unit should be installed so that the control interface is accessible to users and that there is clear access to the electrical panel at the back of the system. Where incorrect installation has occurred warranties may be void or additional charges may be required to ensure that the system is compliant with the manufacturers guidelines.

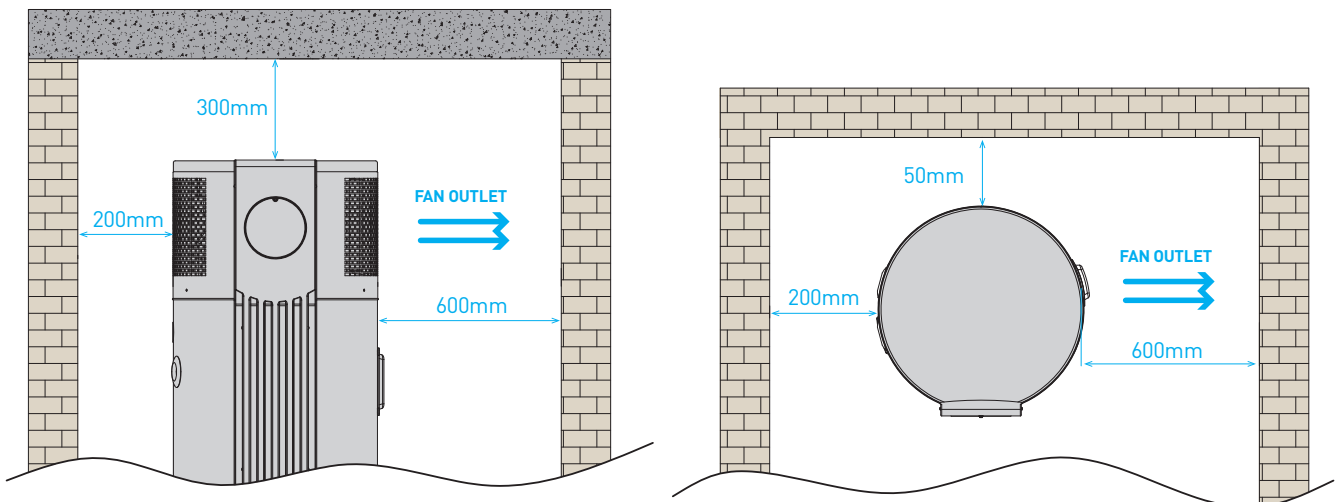
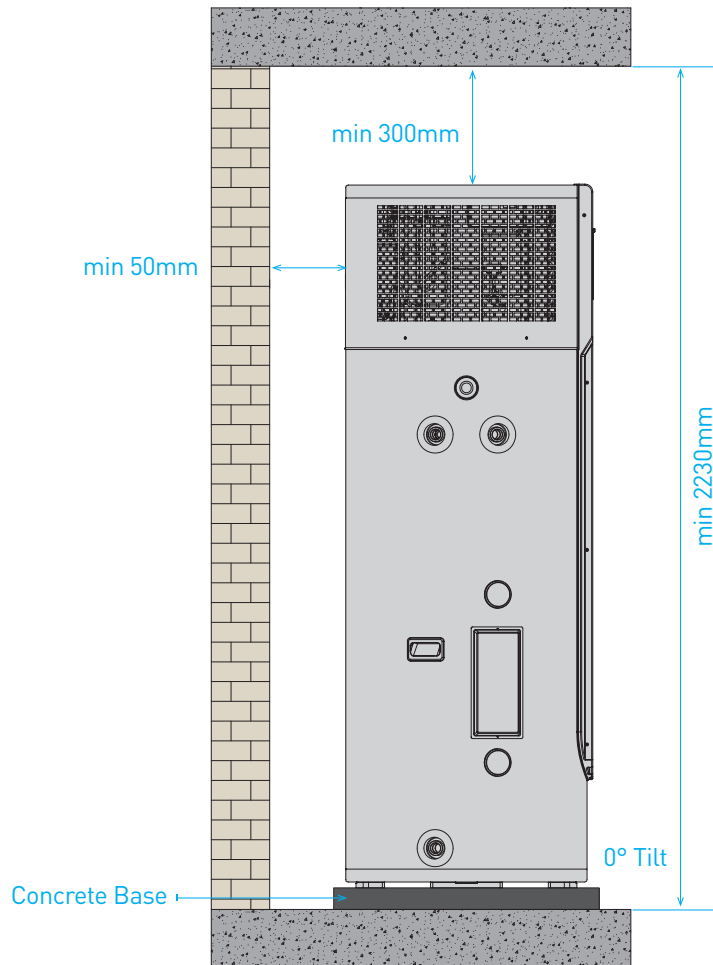

Figure 6 The minimum spacing required for the sufficient air flow from the system

INSTALLATION CONT.

5.3 Base

- The Support surface must be flat (i.e., horizontal) and designed so it can bear the heat pump's weight, is easy to install vertically, and designed to minimize noise or vibration from the unit.
- The unit should be installed on a concrete plinth or stable structure capable of sustaining weights in excess of 400 kg. The supporting structure must not shift over time (due to water drainage etc.). A concrete base should be at least 50 mm thick the minimum dimension of the concrete base should be 600 mm x 600 mm.
- Please ensure that all four feet are supported on the concrete base being used failure to do so may void the products warranty.
- Proper drainage should be observed for any overflow in accordance with AS/NZS 3500.2.
- When installed the unit must be completely vertical and level as to ensure that any condensation can be properly drained away from the unit, failure to do so may void the product warranty.



CONCRETE BASE

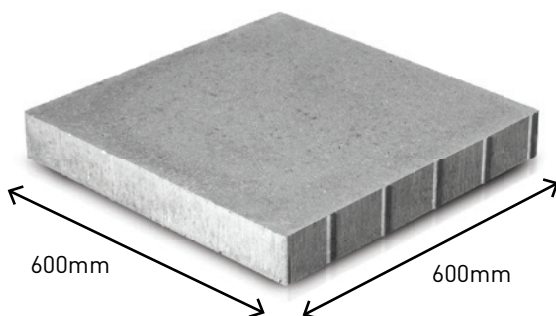

Figure 7 Minimum spacing around the heat pump and a sample dimension of base support

5.4 Plumbing

The plumbing of system is shown below.

- The water inlet/outlet port connections are at G 3/4"
- All pipework must be sufficiently insulated with a minimum 13 mm closed cell insulation that is IP rated.
- Only use quality copper piping for the final connections to the unit.
- Connect the pipes according to the drawings supplied and insulate all pipes.
- The water inlet/outlet requires a fitting.
- The safety relief valve comes with the product and must be fitted and piped to the drain that has been installed.
- The safety relief valve on the tank, the PTRV (item #4 in figure 8), needs to be opened every six months to ensure it works correctly and is not blocked. Failure to do so may void the warranty.

- The process of heat extraction from the atmosphere through evaporator coils results in the production of water in the form of condensation. To collect this water by-product a Condensate Tray is located on top of the water storage tank. Overflow from this tray runs out through the Condensate Drain (item #3 in figure 8). The systems condensate drain is connected by a 1/2-inch copper elbow. Drain the condensate from the elbow to the nearest drainage using copper, PVC, PPR, or PEX pipes. If not drained properly, the condensate line will attract termites as well produce algae and moss growth. The Condensate line should be free of kinks and as the water is gravity fed, this should be vertical to ensure the free flow of water. Connecting any pipe directly to the condensate line without an air gap will void warranties.

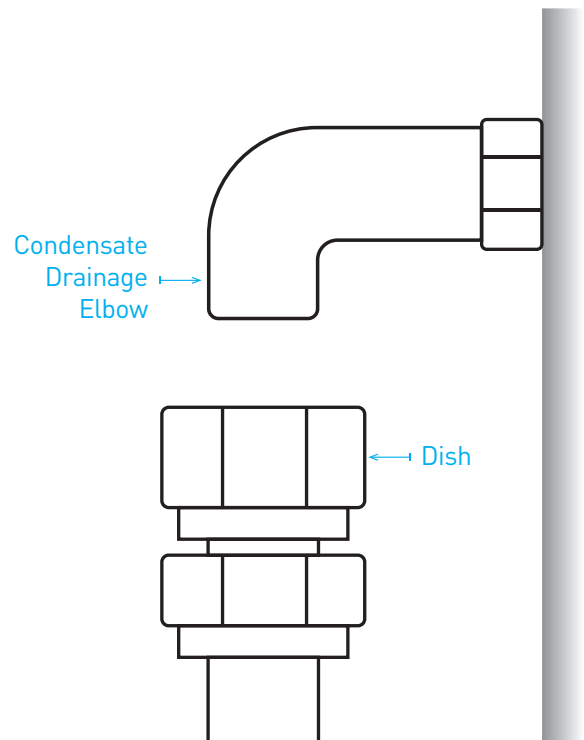
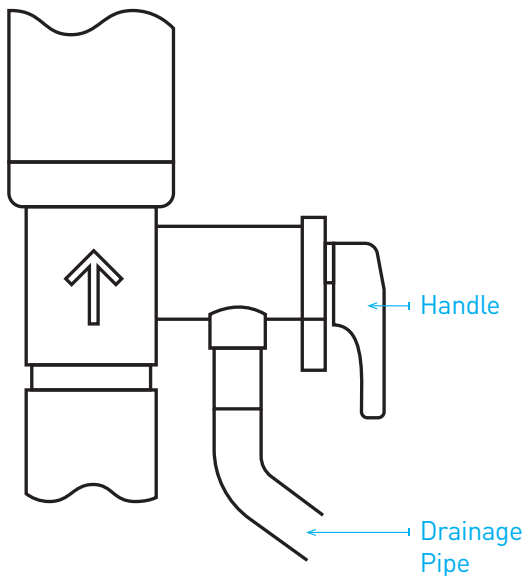

INSTALLATION CONT.

- Insulate the drainage pipe to avoid freezing in cold weather.
- Do not hold down the handle of the safety valve as this could damage it.
- Ensure the drain is clear of any blocks.
- Once all the pipe work is complete and all connections are tight, the install can commence filling the unit with cold water. Open the cold-water inlet isolating valve to begin the process. As the water begins to fill up inside the tank, you can release the buildup of pressure by slowly opening the safety relief valve. Repeat this process until the tank is full and water begins to flow out of the safety relief valve.
- The minimum cold-water pressure must be 200 kPa
- During operation and heat pump cycle, there will be condensation droplets forming within the heat pump. Always ensure the condensate pipe is connected to the drainage network.
- PTRV
 - The system is supplied with a loose Pressure & Temperature Relief (PTR) valve appropriate to the pressure rating of the water heater tank. If the PTR valve is not present, please contact your supplier. The valve Rated capacity: 850kPa; 10kW; Set temperature: 93-99°C.
 - The supplied PTR valve must be installed at Point 4 in the below figure.
 - The PTR valve must be insulated
 - The relief valve must be installed so that the drain line is facing downwards at all times with the discharge point remaining open to the atmosphere.
- Pressure reducing valve
 - It is mandatory to be installed in accordance with AS 3500. This must be rated 500 kPa on the cold inlet to the tank.
- Tempering valve
 - It is mandatory to be installed in accordance with AS 3500. The typical set point is 50°C.

- Expansion control valve
 - The local requirements must be checked with the installer to see if this is required as part of the installation. This should be rated no more than 700 kPa.
- Non return isolation valve
 - It is highly recommended that this is installed to allow the hot water system to be isolated from the rest of the homes water supply, making servicing, draining and replacing the unit easy.

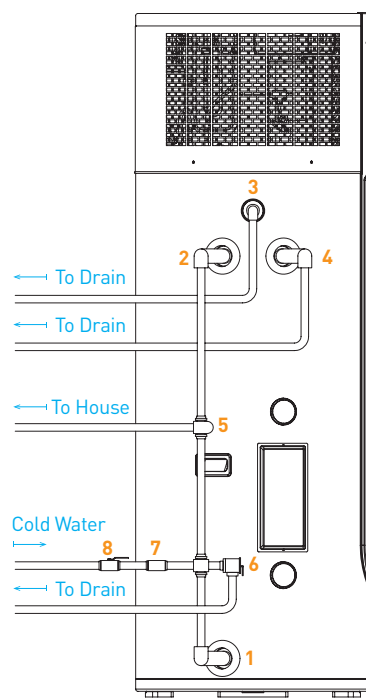

Figure 8
Detailed Plumbing diagram

1. Cold water supply outlet (G3/4" female thread)
2. Hot water outlet (G3/4" female thread)
3. Condensing drainage elbow*
4. P&T relief valve* (G1/2" female)(850kPa)
5. Tempering valve (high performance recommended)
6. Expansion Control Valve (ECV) (if required by council 700kPa)
7. Pressure valve (500kPa)
8. Non-return/isolation valve

*supplied with the system

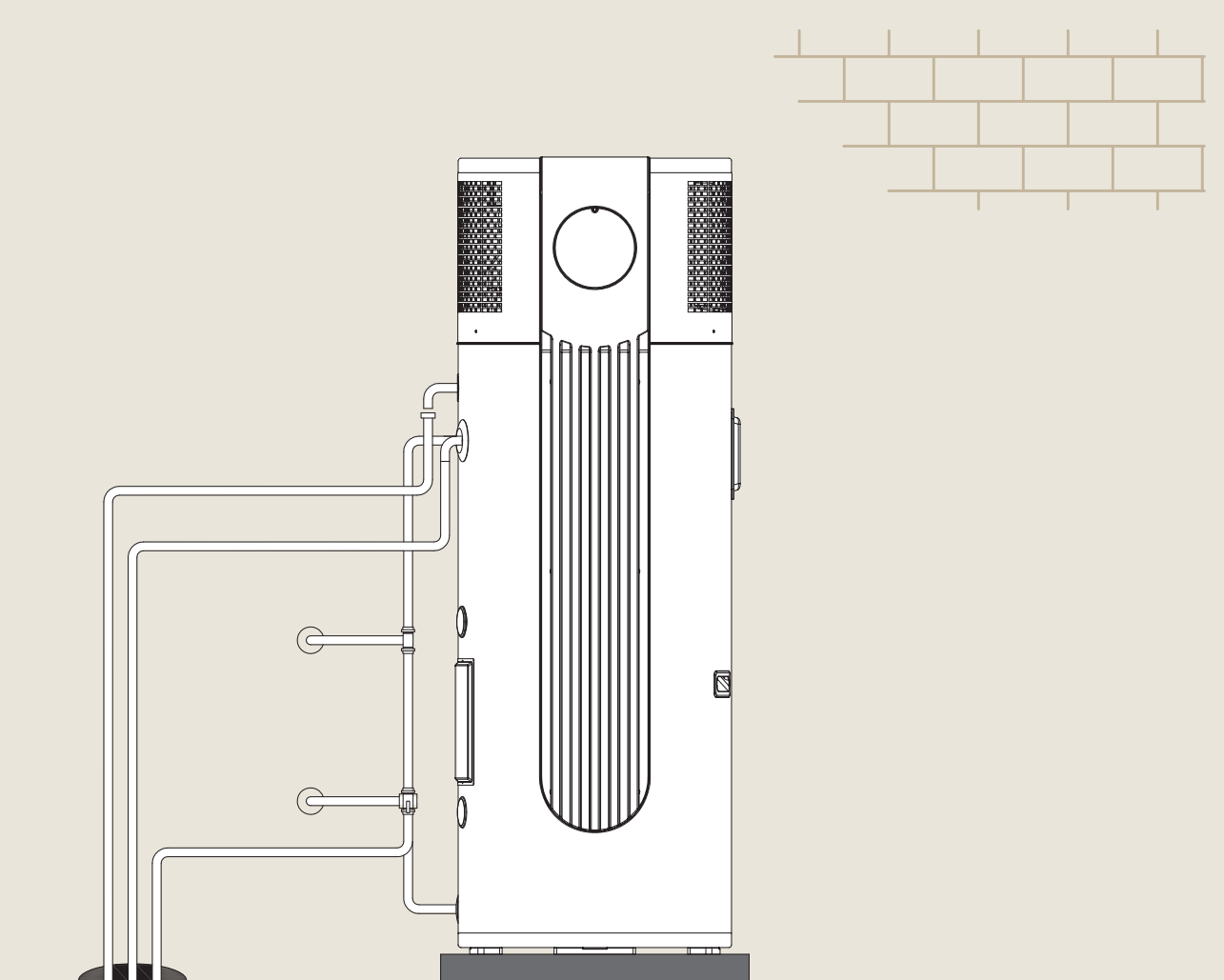

Figure 9 Plumbing diagram of system (left and side view)

INSTALLATION CONT.

- Filling the water tank and air bleeding the system
 - After all plumbing and valves are installed, the tank can be filled and pressurized. Open the non-return valve on the cold-water inlet to begin filling the system with water. At the same time, ensure at least one hot water tap is open inside the house. While the system begins filling with water you will hear air being expelled from the open hot water tap. This is called “bleeding the system” and it ensures that no air pockets remain. Once water begins running out of the hot water tap, the system is completely bled, and you can then turn the tap off.
 - Always ensure that the tank is completely full before connecting and turning on electricity supply.

5.5 Electric Wiring

The electrical connections must be completed by a qualified and trained professional and in accordance with the local and national regulations (AS 3000).

- This product must be wired on a dedicated circuit protected by a 20A circuit breaker.
- The circuit must be connected to a reliable earth electrode connected to the unit.
- The testing of the circuit and final connections are the responsibility of the trained installer.

The key specifications are summarised in the Table below:

Power supply	Cable Size (mm ²)		Protection Device RCBO Type (B)		Earth Leakage
	L&N Conductors	PE Conductor	Rating (A)	TYPE	
220V/50Hz	Φ 2.5 mm	Φ 2.5 mm	20	20	30 mA

Table 1 Key wiring specifications

INSTALLATION CONT.

5.5.1 Power Supply circuit

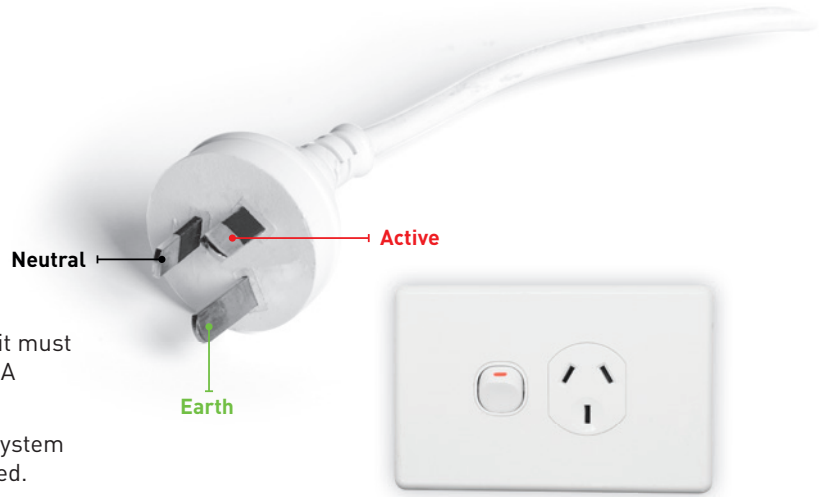

- The unit is supplied with a 3-pin plug. The unit must be on its own dedicated 20 A circuit with a 20 A circuit breaker.
- Instead of using a 3-pin plug, hard wiring of system to a 20A isolator switch is highly recommended.



1. Electrical Cabel
2. Electrical Access

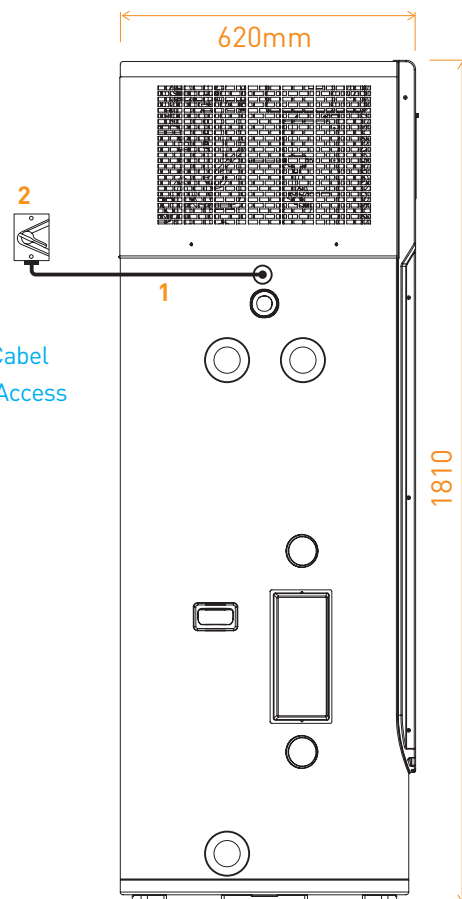

- Before any work can commence ensure that the heater is isolated from the power supply at the switchboard.
- If the supply cord is damaged, it must be replaced by either the manufacturer, a service agent or similarly qualified person to avoid a hazard

INSTALLATION CONT.

5.5.2 Wiring diagram

Diagram below shows the overall internal wiring of heat pump system:

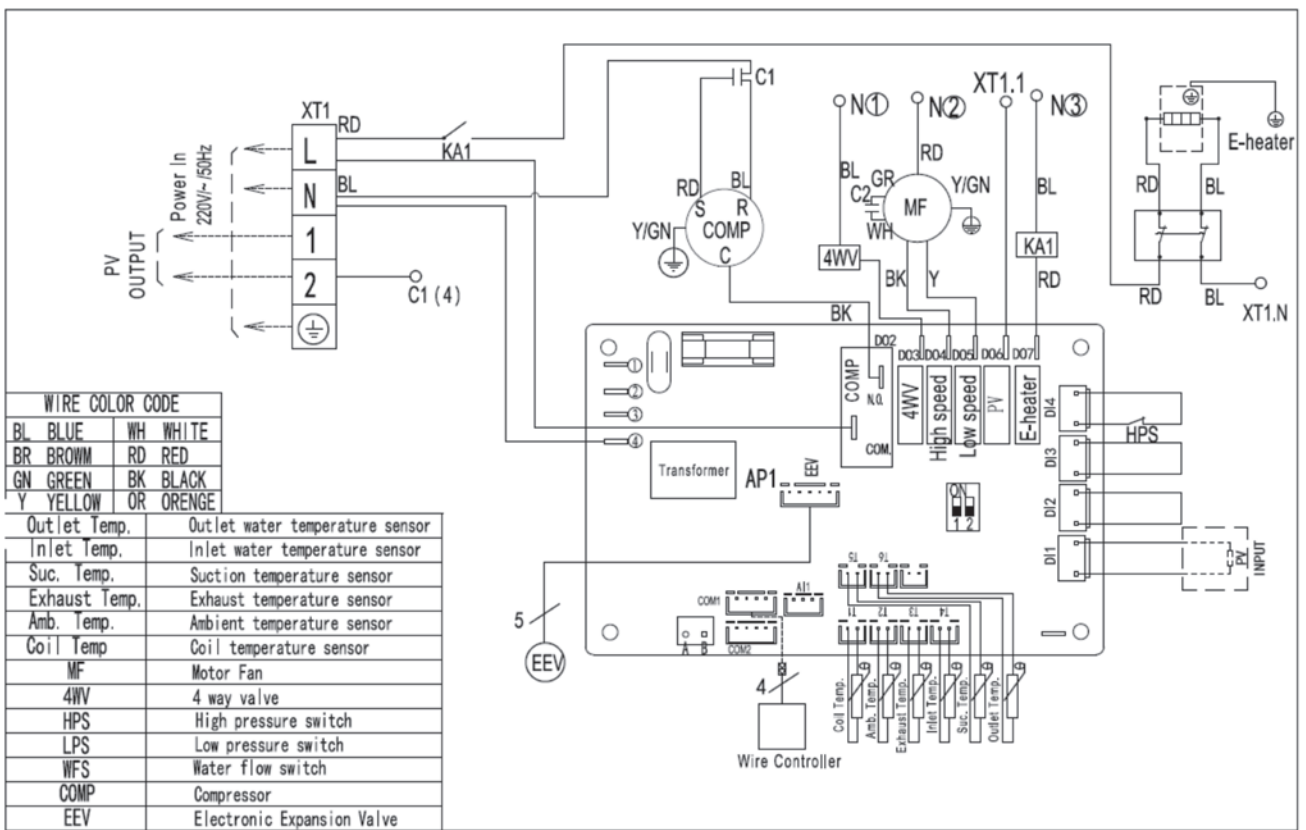

Controller & Operational Modes

The built-in touchscreen controller is installed behind the front cover as it is shown below.

The key features of the touch screen controller are as follows:

- Voltage: 220V~±10%,50Hz±1Hz.
- Temperature accuracy: ±1°C

The key functions of the controller are as follows:

- To display the water temperature at sensor level on the tank- approximately at 55% level of the tank
- To set the operational modes and/or set operational time window for the heat pump
- To display the operational parameters such as the accumulative power usage, coil temperature, ambient temperature, and exhaust temperature and so on
- For automatic defrosting and Anti-freezing function
- To highlight any error codes and/or queries
- For the Wi-Fi connection to mobile app

6.1 Controller, operational modes, and mobile app

The system heat up is based on the temperature of the water in the tank, determined by the thermal sensor (i.e., located at the 55% level on the tank). Given the fact that the heat pumps wrap around heat exchanger is located at the bottom to the middle of the tank and given the stratification of hot water, the sensor at the middle of the tank represents the average full tank temperature of the water stored. The system can work in two operating modes, one that uses energy generated by heat pump exclusively (used without the electric element) or alternatively in conjunction with the in built electric element. The table below highlights the different operating modes of the unit. The system comes with four operational modes. The default operational mode is the "ECO" mode and the key difference between the different operating parameters are explained in the Table below and are as per follow:

AUTO: The system maximum temperature at the sensor level is set at 60°C. If heat pump is not operating, this temperature will be achieved via the electric element. The deadband is 5°C which means as soon as the temperature drops below to 55°C, the system will heat up the tank again until the target temperature is reached.

ECO: The set point of 60°C will be achieved by using the heat pump only. The deadband for thism mode is 12°C means once the 60°C is achieved once, the next cycle will not start until the tank temperature drops to 48°C.

BOOST: With this mode, the heat pump and electric element work together to heat up the tank as fast as possible. In this mode, the set point can be set up to 70°C.

ELE: This mode will heat up the tank solely based on using the electric element. This is only recommended if the heat pump is faulty and out of service. Alternatively, this mode is suitable when the ambient temperature exceed the limits of operational region of the heat pump (i.e. ambient less than -7°C or above +43°C).

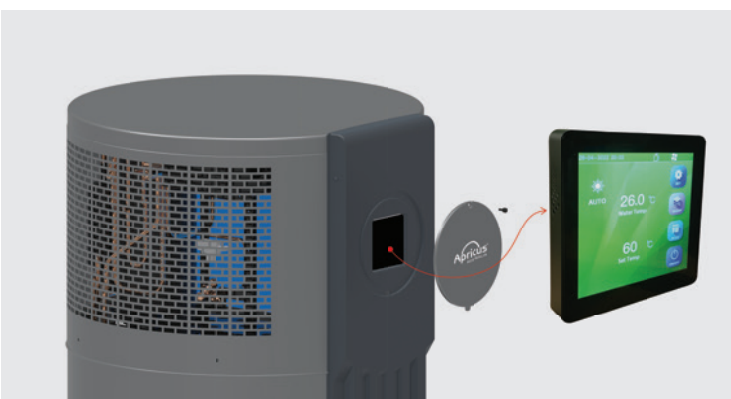

Figure 10 Built-in touchscreen controller

CONTROLLER & OPERATIONAL MODES CONT.

Mode	Temperature range (C)*	Maximum temperature by the heat pump (C)	Maximum temperature by the element (C)	Maximum Water temperature (C)	Restart temperature (C)	Heat Pump dead band (C)	Element dead band (C)
AUTO	60	60	60	60	55	5	-
ECO	60	60	-	60	48	12	-
BOOST	60-70	60	70	70	50-55	5	10
ELE	60-70	-	70	70	60	-	10

Table 2 The settings of 4 operational modes – the factory default is ECO mode, and the end user can change among the modes using the controller.

* The temperature in this table is the measured temperature by tank sensor temperature and this is marked as "Thermal Sensor" on the tank/drawings.

In addition to the four operational modes listed above, the controller also has an internal timer. This means the runtime of the system can also be set on different time blocks (i.e., up to 3 timer blocks) this will be described in the next section. With the default controller supplied, the timer is off which means that the system works according to table above 24/7. If the timer is activated by the end user, the operational modes above will only be activated during the selected timetable highlighted above.

Operational Requirement

Apricus AIO unit is complying with legionella bacteria control based on reaching 60°C at 45% level of tank daily. If that is not achieved by normal options/timer set by the end user, system will start at a random time based on the last time reaching 60°C in a 24-hr cycle at that level, to ensure legionella control is met daily.

6.2 Illustrations on how to use the controller

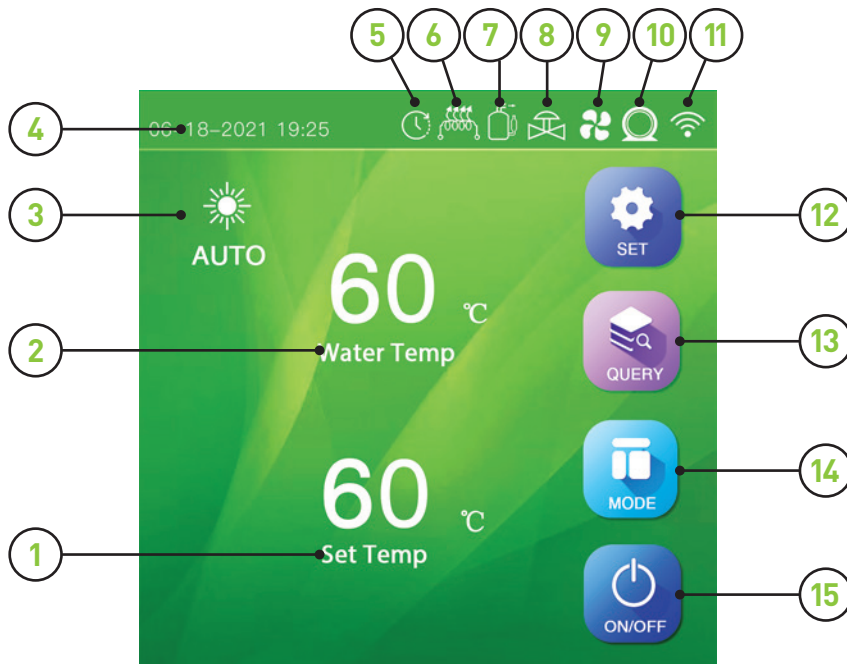

Figure 11 Home page of the touch screen controller

1. Set Temperature

Different modes correspond to different setting temperature values

- a. **AUTO** – default 60°, not adjustable.
- b. **ECO** – default 60°, not adjustable.
- c. **BOOST** – default 70°, setting range 60-70°.
- d. **ELE** – default 70°, setting range 60-70°.

2. Current Water Temp

3. Four Heating operation modes (AUTO, ECO, BOOST, ELE)

4. Date and time (Actual time could be set by this icon)

5. Timer (When the timer is activated, the icon appears; When the timer is deactivated, the icon disappears)

6. Electric heater (When the element is activated, the icon appears; When the element is deactivated, the icon disappears)

7. Compressor (When the compressor is running, the icon appears; When the compressor is not running, the icon disappears)

8. 4-way valve (When the defrost mode is activated, the icon appears; When the defrost mode is deactivated, the icon disappears)

9. Fan (when the fan is running, the icon appears; When the fan is not running, the icon disappears)

10. Solar Photovoltaic (When PV mode is activated, the icon appears; When it is deactivated, the icon disappears)

11. WIFI (When WIFI is connected, the icon appears; When WIFI is disconnected, the icon disappears)

12. Set menu (click to enter the setting interface)

13. Inquiry menu

14. Mode menu

- a. you can switch the mode "AUTO", "ECO", "BOOST", "ELE"

15. Switch on or off the system

In the off state, press the "ON/OFF" key in the main interface, it will turn on immediately. Conversely the unit will shut down if it is on. When the screen is off, tap the screen anywhere to light up the touch screen before operation. After five minutes, of non-operation the touch screen will become dark and only the water temperature is displayed.

6.3 Set Water Tank Temperature

Tap **SET TEMP** on the main interface, and then tap “+” and “-” to adjust or decrease the set tank temperature, and then tap “OK” to confirm the setting.

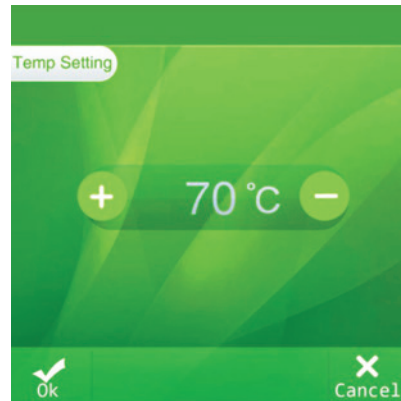

6.4 Menu interface

The relevant items for the installer and end users are

- Timing
- Wi-Fi
- Brightness
- Clock

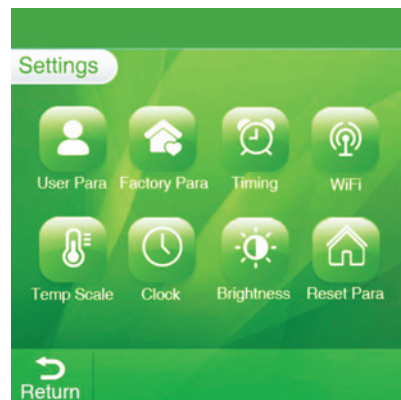

Timing

6.4.1 Timer/timing

Tap **TIMING** to enter the timer setting interface. Timing settings can be set for 3 periods of time, “**Timing 1**”, “**Timing 2**” and “**Timing 3**”. In each group, the end user can set “**Timing on**” and “**Timing off**”. When “Timing On” and “Timing Off” are the same, the default state is “Invalid” - in other words, on and off times cannot be the same. After setting is completed, tap “**ON/OFF**” button to enable/disable the timer.





6.4.2 Wi-fi

Click **WiFi** to enter the WIFI network state selection. Select different modes to operate the network according to your needs.

EZ mode: Smartconfig means that the mobile APP will send a UDP broadcast packet or a multicast packet containing the WIFI username and the WIFI password communicated between the heat pump by entering details into the app. The WIFI chip can receive the UDP packet, as long as the UDP organization form is known, the WIFI username and password are decrypted by the UDP packet, and the WIFI username and password received by the hardware configuration are sent to the designated WIFI AP.

AP mode: APP configures the mobile phone to connect to the intelligent hardware (AP of the WIFI chip). The mobile phone and the WIFI chip directly establish communication, and the WIFI username and the WIFI password to be configured are sent to the intelligent hardware, and the intelligent hardware can be connected at this time.

Compared to the AP mode, the EZ mode is easier to use and quicker during first network pairing. However, some mobile phones and devices are incompatible with the EZ mode and require the AP mode.

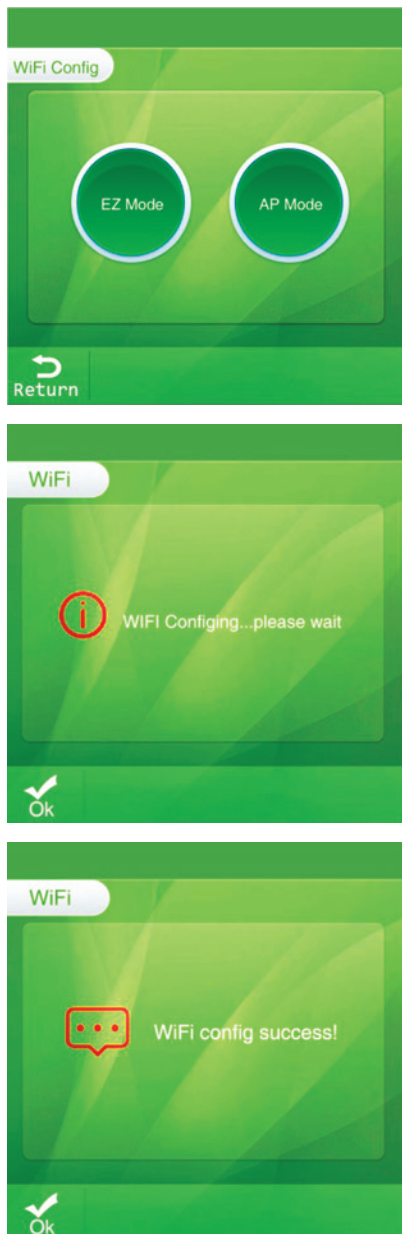



Clock

6.4.3 Clock settings

Click **CLOCK** to enter the real-time clock setting.



Brightness

6.4.4 Brightness settings

Click **BRIGHTNESS** to set the screen brightness.



QUERY

6.5 Query interface

Operating Temperature Query

Tap the “**TEMPERATURE**” key to enter the temperature query interface, displaying the real-time temperature of each temperature point.



System Status Query

Press the “**SYSTEM STATUS**” key to enter the system status query, displaying the working status of the heat pump system. Press “**NEXT**” to turn the page after, press “**PREV**” to turn the page before.

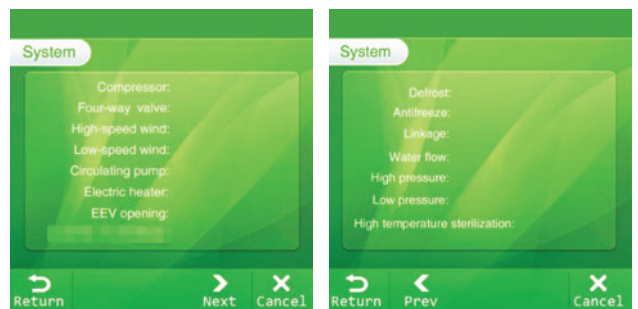

CONTROLLER & OPERATIONAL MODES CONT.

Power Management Query

Homeowners can view the voltage, current, power and accumulated power consumption (you can reset and clear the accumulated power consumption: password 1234)

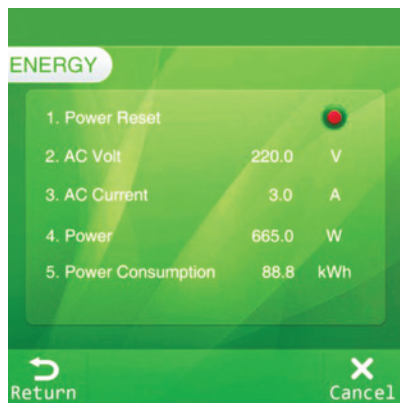

Software & Hardware Version Query

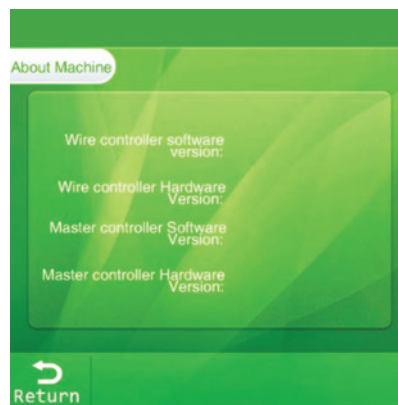

History Fault Inquiry

Tap the "FAULT INFO" key to view the history of faults, you can query the recent history of faults and the corresponding occurrence time;
Tap "CLEAR RECORD" key to clear the fault record.

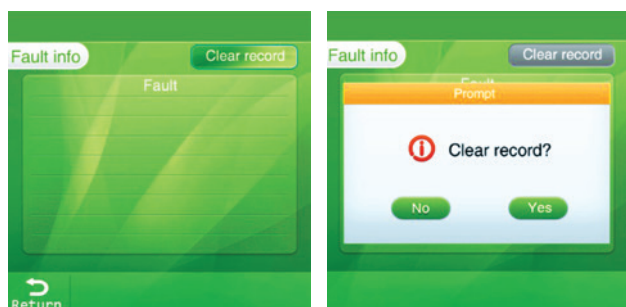

6.6 Wi-fi and Mobile App Set Up

Please follow below steps to set up and operate Wi-Fi functions.

1. Prepare a Wi-Fi wireless router that can access the Internet, The Wi-Fi frequency band is required to be 2.4 Ghz and it should be placed within 10 meters of the water heater to ensure that a strong Wi-Fi signal is available.
2. Turn on Wi-Fi and Bluetooth on your device. After the connection is successful, you can turn off Bluetooth and operation will not be affected.
3. Scan the QR code below or search in the app market to download and install the 'Smart Life' App.
 - iOS users – please download from App Store
 - Android users – please download from Google Play
4. After completing the installation, open the App, register an account and log in according to the App prompt.
5. To connect the controller to your network Press and hold the On/Off and the Up (🏠+🔼)keys together for 5s, to enter into manual network connection mode. When the controller is available for connecting to a Wi-Fi network, the symbol “📶” will flash. When connected successfully, the symbol “📶” will remain continuously lit up.

 **YOU WILL NEED TO REPEAT STEP 5 IF THE ICON STOPS FLASHING DURING THE CONNECTION**

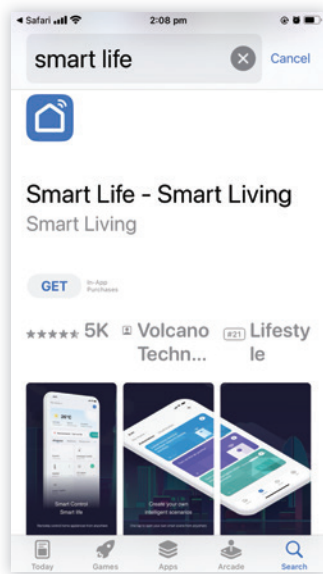

CONTROLLER & OPERATIONAL MODES CONT.

6. Connect to the “Smart Life” App as follows:

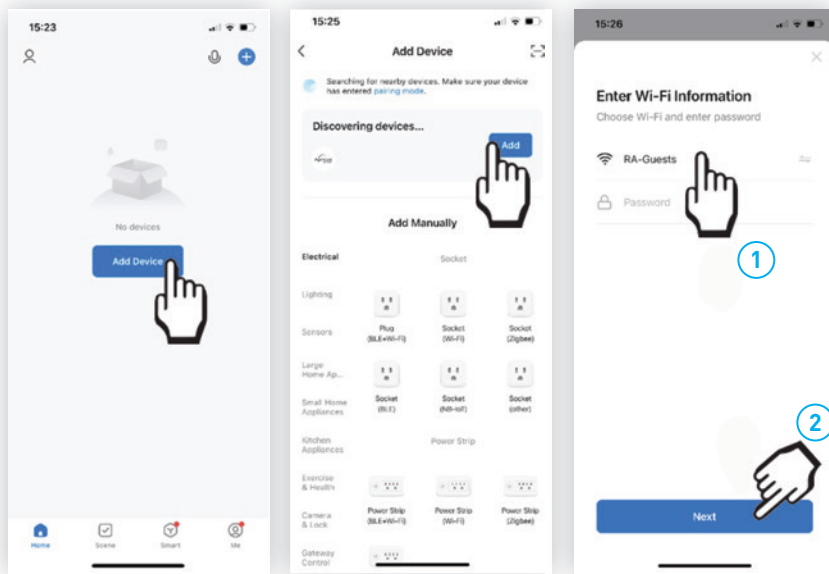

- i Search for device
- ii Add found device
- iii Connect to Wi-Fi

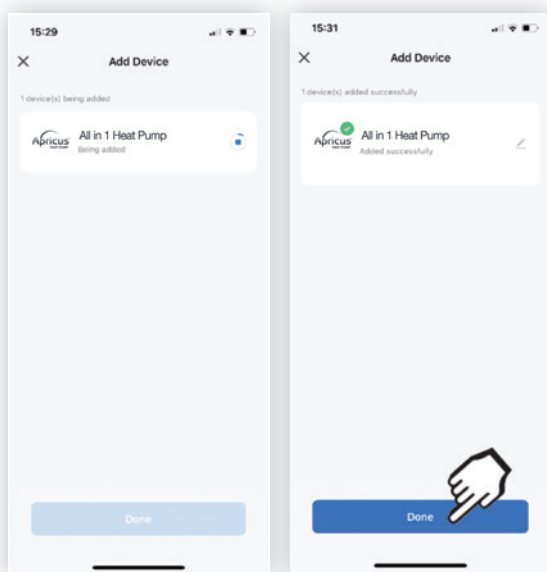

- iv Wait for connection
- v Complete

7. Control the Heat Pump with the App

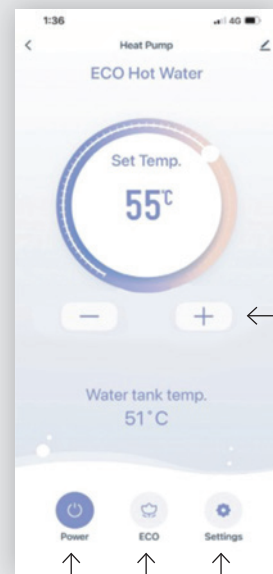

Adjust Temp. Settings

Turn On/Off
Select Mode

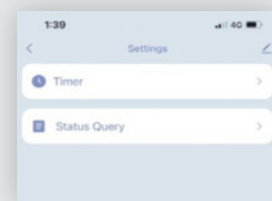

Timer/ Check Operation

6.7 Mobile App (Smart Life)

The instructions on how to pair a mobile phone app with the controller on the tank using the house Wi-Fi is given in the commissioning section. The mobile app can be used for the following purposes:

- Monitoring the system operational parameters such as Power usage (Accumulative- but this can also be reset), Tank temperature, Ambient temperature. Access the monitoring data by clicking on the **SETTING ICON** on the bottom right of the app.
- Adjust the mode of operation and set the tank temperature AUTO, ECO, BOOST, ELE. To change modes, click on the mode icon which is the middle icon at the bottom of the main screen.
- Using the time function. Access this by clicking on the **“SETTINGS”** icon and this is the last item on the settings page.
- Turning on/off the system
- Sharing device with the manufacture or the family member

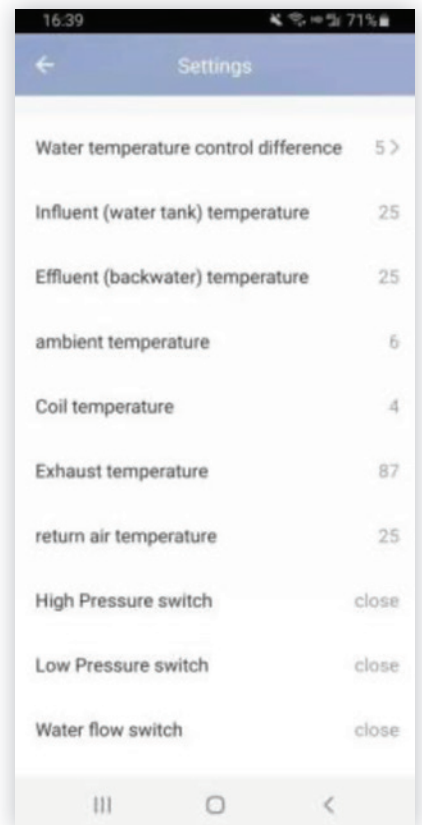
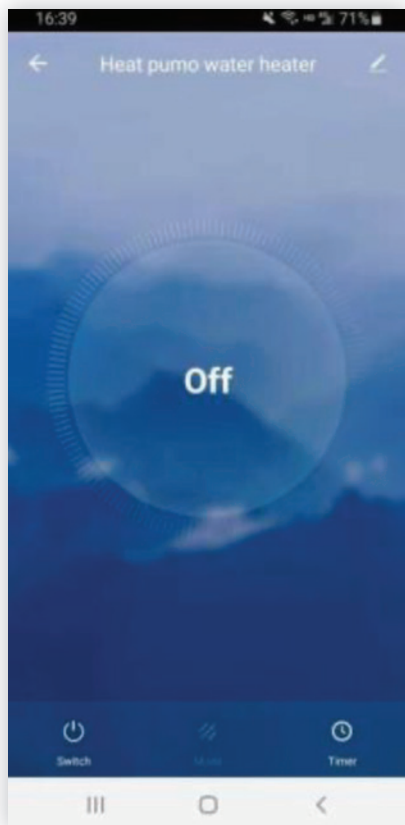

CONTROLLER & OPERATIONAL MODES CONT.

The timer function is the last item on the settings page. The timer function can set up to 3 operational windows and there are additional settings available such as selecting the day of the week.

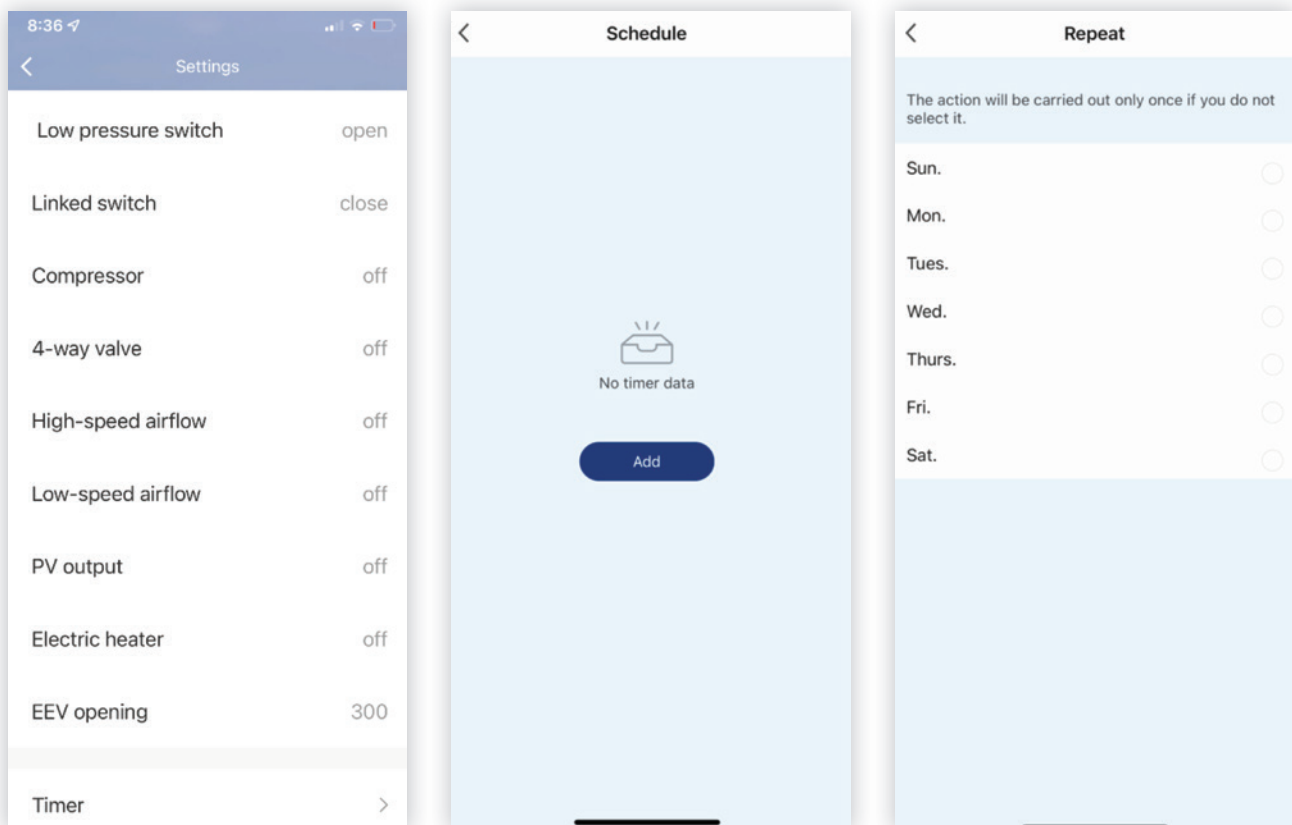

Commissioning

7.1 Plumbing and electrical

Once both the electrical and plumbing connections have been completed by a qualified trades person, the system is now ready for operation. Before turning the system on it is essential that you ensure the heat pump storage tank is full and the unit is thoroughly flushed. Air pockets must be bled from the system via a hot water tap inside the house whilst also using the PTRV to bleed air out of the system.

Some key checks include:

- The system is level
- The spacing around the unit is compliance with Figure 7 and Figure 8
 - A minimum distance of 300 mm is present above the system
 - A minimum distance of 600 mm is present on the fan discharge side and 150 mm on the air in-take sides of the system to support airflow
 - A minimum distance of 150 mm is present between the exterior of the tank and wall for air circulation and servicing
- The drain water is not blocked and can be drained with gravity.
- All exposed piping is fully insulated.
- The system is connected to a dedicated 20A circuit.
- The cold-water pressure is 200 kPa or greater.
- The appliance is installed in accordance with national wiring regulations
- Ventilation openings are clear of obstruction.
- Mechanical connections are accessible for maintenance purpose.
- The instructions given in this manual for handling, installing, cleaning, maintaining and disposing of the refrigerant are followed.
- **WARNING:** The appliance must not be stored in a room with continuously operating open flames (for example and operating gas appliance) and ignition sources (for example an operating electric heater).
- Any work completed on the unit must be completed by a qualified and competent person.

7.2 Controller and operational mode set up

- After speaking with the system owner, the installer must select the appropriate operational mode.
 - Auto, Eco, Boost, Elec
- If required, the timer function and appropriate time slots for running the system must be selected using the timer function using **SET > TIMING**.

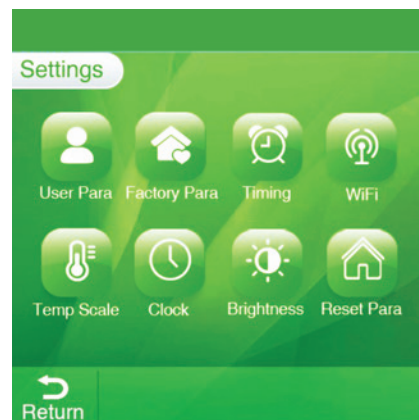

Error Codes & Troubleshooting

Please follow the steps below and contact the service provider for further information and support if required.

SN	FAULT CODE	POSSIBLE CAUSES OF FAILURE
1	High Pressure Protection	<ol style="list-style-type: none"> 1. Too much refrigerant in the system 2. Fluorine system is blocked or air incoming 3. Pressure switch failure 4. Whether the fan is working properly 5. Mainboard failure
2	Over Temperature Protection of Exhaust Gas	<ol style="list-style-type: none"> 1. Sensor or sensor connection line failure 2. Fluorine system lack of refrigerant or air into the system 3. Electronic expansion valve opening degree is abnormal 4. Whether the fan works normally 5. Mainboard failure
3	Coil Temp Fault	<ol style="list-style-type: none"> 1. Sensor or sensor connection line failure 2. Mainboard failure
4	Ambient Temperature Fault	Same as fault 3
5	Hot Water Tank Temp Fault	Same as fault 3
6	Exhaust Temp Fault	Same as fault 3
7	Return Air Temperature Fault	Same as fault 3

Table 3 Error code display and possible causes/solutions

ISSUE	POSSIBLE REASONS	APPROACH
The outlet water is cold and/or the screen is dark	<ul style="list-style-type: none"> • The plug is not plugged properly • The temperature controller is on the lowest temperature control state • The temperature controller is damaged • The circuit board of the indicator lamp is damaged 	Plug in properly. Set the temperature of the controller in higher state
No water out from the hot water outlet	<ul style="list-style-type: none"> • The tap water is cut off • The water pressure is too low • The tap water inlet valve is closed 	Waiting for the restore of the tap water. Wait and use when the water pressure is raised. Open the tap water inlet valve.
Water leakage	Check the tightness and sealing of the fittings on the connecting points between pipes.	Improve the tightness of the connecting points

Table 4 Some common issues and initial troubleshooting guidance

Maintenance

1. Check the system always has power.
2. When not used for a long time and the owner decides to cut off the power to the unit temporarily, the water filled in the water tank must be drained out to prevent from damaging the inner tank.
3. The storage tank comes with an anode inside, over time the anode will break down/dissolve which is designed to extend the life of the tank. Different water quality will have a different effect on the time the anode takes to breakdown. It is recommended that the anode be checked very three years is replaced if required. Failure to do so will void the warranty.



Warranty

When proof of installation date is not provided, the start date of the warranty will commence from the system date of manufacture determined by the systems unique serial identifier. It is recommended that homeowners keep receipts, invoices, warranties, and any installation record forms where applicable, in a safe place.

10.1 Warranty periods

The system is supplied with a six-year parts and labour warranty from date of installation. Eligibility requirements to make a claim

- The person(s) making the claim must be the product owner or have consent to act on behalf of the owner.
- The person(s) making the claim must contact Solar thermal Australia as soon as they notice any defect(s) without excessive delay, and the product must be within its warranty period.
- The product must have its original serial numbers and/or rating labels where applicable.
- The product must be installed in Australia.
- The warranty period begins from the date of installation of the component(s), in the event that proof of installation cannot be provided, the period begins from date of purchase, and in the event that this is also not available, the warranty will begin from date of manufacture of the product

General warranty conditions

- 1.1. This Warranty is for domestic & residential use of the hot water heating system only. Any application with hot water consumption above 700 L/day is considered NON-residential. Domestic is defined per below:
 - a. Units installed in any domestic dwelling.
 - b. Hot water consumption below 700 Liters per day.
- 1.2. Any application with hot water heating where system(s) are used as finishing tank(s) as part of a hot water heating installation, warranty period is one-year parts and labour ONLY.

WARRANTY CONT.

- 3.1. To the extent that a claim falls under the 'Parts and Labour' Warranty Period, the Warranty covers the repair and/or replacement of such failed component in domestic use and any associated labour costs free of charge. Please note the cost of freight may be charged to the customer.
- 4.1. The decision to repair or replace the component that is the subject of the Warranty will be entirely at the discretion of Solar thermal Australia.
- 5.1. Where a component, in domestic use, is repaired or replaced by Solar thermal Australia, the balance of any original Warranty Period will remain effective. The repaired or replaced part does not carry any additional warranty period.
- 6.1. Solar thermal Australia reserves the right to alter the design, components or construction to its domestic hot water system or custom design. Such alterations shall not constitute a defect in design or construction under this Warranty.
- 7.1. Any claim under this Warranty must include full details of the defect and/or damage to the Solar thermal Australia Domestic hot water system or component(s) in domestic use. All claims must be made within one (1) month of the detection of the defect.
- 8.1. Dated proof of purchase is required prior to commencement of any work under this Warranty.
- 9.1. Solar thermal Australia does not warrant any installation work conducted by the installer of the hot water system or component(s) in domestic use.
- 10.1. This Warranty only applies to the Solar thermal Australia domestic hot water system and its components, or component(s) in domestic use and does not cover any plumbing or electrical associated parts, including but not limited to any parts supplied by any person installing the Solar thermal Australia Domestic hot water system or component(s) in domestic use.
- 11.1. To the extent permitted by law, Solar thermal Australia shall not be liable under this Warranty for any consequential loss or damage or any incidental expenses resulting from any breach of this warranty, including but not limited to, claims for damage to buildings, roofs, ceilings, walls, foundations, gardens, personal belonging or household effects, fixtures and fittings, or any other consequential loss, damage or inconvenience, either directly or indirectly due to leakage from the Solar thermal Australia domestic hot water system or component(s) in domestic use or any other matter related to the system or its operation.
- 12.1. The benefits conferred by this Warranty are in addition to all other rights and remedies in respect of the Solar thermal Australia Domestic hot water system or component(s) in domestic use, which the purchaser has under the Competition and Consumer Act 2010 and consumer protection legislation of the States and Territories. Nothing in this Warranty has the effect of excluding, restricting or modifying those rights.
- 13.1. Goods presented for repair may be replaced by refurbished goods of same type rather than being repaired. Refurbished parts may be used to repair/replace the goods.
- 14.1. This Warranty is effective for all Solar thermal Australia Domestic hot water system or component(s) in domestic use installed after 1st January 2019.
- 15.1. If the Customer has not paid in full for the Solar thermal Australia Domestic hot water system or component(s), then this Warranty does not apply (Proof of purchase is a MUST).

WARRANTY CONT.

- 16.1. The Solar thermal Australia domestic hot water system and its components or component(s) in domestic use are covered by a warranty against defective factory parts or workmanship from the date the Solar thermal Australia domestic hot water system or component(s) in domestic use is installed for the relevant period for such component as outlined in Table 1 – Warranty Periods. If the date of installation is unknown, the Warranty commences three (3) months after the date of manufacture.
- 17.1. Solar thermal Australia goods come with guarantees that cannot be excluded under the Australian Consumer Law. You are entitled to a replacement or refund for a major failure and compensation for any other reasonably foreseeable loss or damage. You are also entitled to have the goods repaired or replaced if the goods fail to be of acceptable quality and the failure does not amount to a major failure.
- 18.1. The heat pump hot water system are covered by Solar thermal Australia for any cost of labor and parts in the event of a Component failure due to any defects that may arise either from workmanship and or faulty material. The Warranty commences on the date of installation.
- 19.1. Solar thermal Australia does not accept liability for consequential damage or any incidental expenses resulting from any breach of the Warranty.
- 20.1. The Solar thermal Australia warranty does not cover the following:
- a. Subject to any statutory provisions to the contrary, claims for damages to walls, foundations etc. or any other consequential loss caused either directly or indirectly by leakage from the heat pump hot water system or any other faults.
 - b. Warranty does not cover any faults that may arise from connecting to a water source that is unfiltered such as dams, bores, rivers etc.
- 21.1. The warranty will be rendered void in the following circumstances
- a. Failure due to misuse, natural disasters, Acts of God, accidental damage, installation by an installer who is not unauthorized to install a Solar thermal Australia heat pump hot water system or incorrect installation and attempts to repair Solar thermal Australia by an unqualified person.
 - b. Repairs and service carried out by a person who is not a Qualified Service Person or Authorized Service Agent.
 - c. Faults caused by incorrect installation, water problems and or electricity supply.
- 22.1. Where the Solar thermal Australia heat pump hot water system is installed in a position that does not allow safe, ready access, the cost of accessing the site safely, including the cost of additional materials handling and/or safety equipment, shall be the owner's responsibility.
- 23.1. This Warranty does not apply to any defects or damage NOT due to faulty factory parts or workmanship including, but not limited to, defects or damage caused by or resulting from:
1. accidental damage, storm damage, vandalism, failure due to misuse or abuse, or neglect of any kind;
 2. incorrect or improper installation of the Solar thermal Australia heat pump hot water system, including but not limited to, installation otherwise than in accordance with the instructions contained in the owner's manual supplied by Solar thermal Australia or incorrect system selection;
 3. alteration or repair of the Solar thermal Australia Hot Water Heating System other than by a licensed plumber or by an approved Solar thermal Australia agent;

WARRANTY CONT.

4. attachment of any parts or accessories other than those manufactured or approved by Solar thermal Australia;
5. freezing in regions with minimum temperatures below -10 C
6. the power supply to the Solar thermal Australia Hot Water Heating System being cut;
 - a. power surges.
 - b. animals, birds and/or rodents.
7. excessive water pressure, negative pressure (partial vacuum), excessive temperature, corrosive atmosphere
8. faulty plumbing and/or electrical wiring.
9. Sludge/sediment because of connection to a water supply from filtered or treated sources ie. spring, dam, bore, river or town supply from a bore.
10. contamination and corrosion from particles in the water supply.
11. serial tags/stickers on any of the components being removed or defaced.
12. the Solar thermal Australia Hot Water Heating System being relocated from its original point of installation.

10.2 Heat pump warranty conditions

1. All Solar thermal Australia heat pump hot water system must be installed by a licensed installer.
2. Only a licensed professional must Install, Commission or Service Solar thermal Australia heat pump hot water system.
3. All Solar thermal Australia heat pump hot water system must be installed in accordance with Manufacturer’s Installation Instructions and in Accordance with local regulations, municipal building codes and current AS/NZS 3000, AS/NZS 3500, AS 3498 and AS/NZS 5601.

4. If the Solar thermal Australia heat pump hot water system has not been installed in accordance with Manufacturer’s Installation Instructions or installed as to be easily accessible for servicing, a service charge may apply.

1. The integration with tank and controller should follow the instructions in the installation manual.
2. The operational conditions should not exceed from those specified in the installation manual (i.e. -10 to 43 °C).
3. The storage tank MUST have a 850 kPa PTRV installed, while the main cold pressure to the hot water system is limited by a 500 kPa PLV.
4. Electricity supply to the heat pump unit must be accordance with the relevant Australian standards as well as guidelines in the installation manual (i.e. 240 V supply and 20 A circuit breaker).

5. Where a component may have failed under warranty and is replaced, the component replaced will only be covered by the warranty for the balance of the appliance warranty period.
6. Water quality must be within limits specified in Table 5.

WARRANTY CONT.

Total Dissolved Solids	< 600 mg/L or ppm
Total Hardness (CaCO3)	< 200 mg/L or ppm
Electrical Conductivity	850 µS/cm
Chloride	< 300 mg/L or ppm
pH Level	Min 6.5 to Max. 8.5
Magnesium	< 10 mg/L or ppm
Sodium	< 150 mg/L or ppm
Iron	< 1mg/L or ppm
Alkalinity (as CaCO3)	< 200 mg/L or ppm
Dissolved (free) CO2	< 25 mg/L or ppm

Table 5 Water quality requirement for Solar thermal Australia Hot Water Heat Pump Installation

WARRANTY CONT.

10.3 Warranty Registration – Lodge a claim

For all warranty issues please call Solar thermal Australia on 1300 277 428 or email warranty@apricus.com.au.

Provide full product owner's contact details: name of owner, address of installation site, contact number(s), proof of original installation date or if not available, the date of manufacturing and serial number from the rating label, where applicable for heat pump hot water system and tanks.

In order to register your system for warranty purposes, please complete the details of your purchase below, detach and email to warranty@apricus.com.au also make sure to take a proper photo of serial number as well as faulty parts requested by one of our team members:

Your name: _____

Your mailing address: _____

State: _____ Postcode: _____

Product Details: _____

Heat Pump Serial Number: _____

Hot Water Tank Serial Number: _____

Date of Purchase/Installation: _____ / _____ / 20 _____

Suppliers Name: _____

Why Apricus?

We believe in the goal of a sustainable lifestyle and the potential for living off-grid. With over 15 year's experience, we are passionate about the potential of energy efficient and environmentally-friendly heating, or cooling, tailored to Australian requirements.

Through our commitment to product innovation and next generation technology, we truly believe we have designed a pool heat pump system that is one of the most energy efficient and flexible solutions available in Australia today.

Our people are here for you.

We have high quality resellers all around Australia, so talk to one of our specialists and start saving today.

YOUR APRICUS DEALER

1300 383 815
HELLO@APRICUS.COM.AU
APRICUS.COM.AU

**Apricus**[®]
HEAT PUMP